

# LM3508

## Synchronous Magnetic Constant Current White LED Driver

### General Description

The LM3508 is a synchronous boost converter (no external Schottky diode required) that provides a constant current output. It is designed to drive up to 4 series white LEDs at 30mA from a single-cell Li-Ion battery. A single low power external resistor is used to set the maximum LED current. The LED current can be adjusted by applying a PWM signal of up to 100kHz to the DIM pin. Internal soft-start circuitry is designed to eliminate high in-rush current at start-up. For maximum safety, the device features an advanced short-circuit protection when the output is shorted to ground. Additionally, over-voltage protection and an 850kHz switching frequency allow for the use of small, low-cost output capacitors with lower voltage ratings. During shutdown, the output is disconnected from the input preventing a leakage current path through the LEDs to ground. The LM3508 is available in a tiny 9-bump chip-scale micro-SMD package.

### Features

- Drives 4 Series White LEDs with up to 30mA
- >80% Peak Efficiency
- Up to 100kHz PWM Brightness Control
- Accurate  $\pm 5\%$  LED Current Regulation across  $V_{IN}$  range
- Internal Synchronous PFET (No Schottky Diode Required)
- True Shutdown Isolation
- Output Short-Circuit Protection
- 17.5V Over-Voltage Protection
- Internal Soft-Start Eliminates Inrush Current
- Wide Input Voltage Range: 2.7V to 5.5V
- 850kHz Fixed Frequency Operation
- Low Profile 9-Bump Micro-SMD Package (1.514mm x 1.514mm x 0.6mm)

### Applications

- White LED Backlighting
- Handheld Devices
- Digital Cameras
- Portable Applications

### Typical Application Circuit

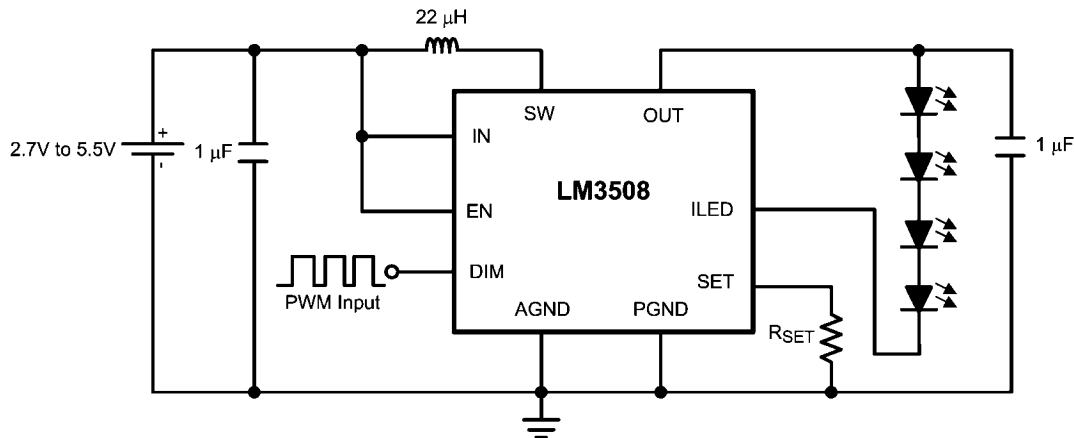

30004201

## Connection Diagram

Top View

Top View

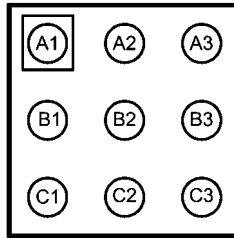

9-Bump (Large)  $\mu$ -SMD (1.514mm x 1.514mm x 0.6mm) NS Package Number TLA09 <sup>30004202</sup>

## Ordering Information

Part Number	Package Type	NSC Package Drawing	Top Mark	Supplied As
LM3508TL	9-Bump micro SMD	TL09SDA	D31	250 Units, Tape and Reel
LM3508TLX	9-Bump micro SMD	TL09SDA	D31	3000 Units, Tape and Reel

## Pin Descriptions/Functions

Pin	Name	Function
A1	PGND	Power Ground Connection.
A2	SW	Inductor connection and drain connection for both NMOS and PMOS power devices.
A3	OUT	Output capacitor connection, PMOS source connection for synchronous rectifier, and OVP sensing node.
B1	ILED	Regulated current source input.
B2	DIM	Current source modulation input. A logic low at DIM turns off the internal current source. A logic high turns the LEDs fully on ( $V_{SET}=200mV$ ). Apply a PWM signal at DIM for LED brightness control.
B3	IN	Input voltage connection.
C1	SET	Current sense connection and current source output. Connect a 1% resistor ( $R_{SET}$ ) from SET to PGND to set the maximum LED current ( $I_{LED} = 200mV/R_{SET}$ ).
C2	EN	Enable input. A logic low at EN turns off the LM3508. A logic high turns the device on.
C3	AGND	Analog ground. Connect AGND to PGND through a low impedance connection.

## Absolute Maximum Ratings (Notes 1, 2)

If Military/Aerospace specified devices are required, please contact the National Semiconductor Sales Office/Distributors for availability and specifications.

$V_{IN}$	-0.3V to 6V
$V_{OUT}$	-0.3V to 22V
$V_{SW}$	-0.3V to 22V
$V_{ILED}, V_{SET}, V_{DIM}, V_{EN}$	-0.3V to 6V
Continuous Power Dissipation (Note )	Internally Limited
Junction Temperature	+150°C
Lead Temperature (Note 4)	+300°C
Storage Temperature Range	-65°C to +150°C
ESD Rating(Note 9)	
Human Body Model	2kV

## Operating Conditions (Notes 1, 2)

Input Voltage Range	2.7V to 5.5V
Ambient Temperature Range (Note 5)	-30°C to +85°C
Junction Temperature Range	-30°C to +105°C

## Thermal Properties

Junction to Ambient Thermal Resistance ( $\theta_{JA}$ )(Note 6)	64.7°C/W
--	----------

## ESD Caution Notice

National Semiconductor recommends that all integrated circuits be handled with appropriate ESD precautions. Failure to observe proper ESD handling techniques can result in damage to the device.

## Electrical Characteristics

Specifications in standard type face are for  $T_A = 25^\circ\text{C}$  and those in **boldface type** apply over the Operating Temperature Range of  $T_A = -30^\circ\text{C}$  to  $+85^\circ\text{C}$ . Unless otherwise specified  $V_{IN} = 3.6\text{V}$ .(Note 7)

Symbol	Parameter	Conditions	Min	Typ	Max	Units
$I_D$	LED Current Regulation	$R_{SET} = 10\Omega$		20		mA
		$R_{SET} = 6.67\Omega$		30		
$V_{SET}$	Voltage at SET Pin	$3.0\text{V} < V_{IN} < 5.5\text{V}$	<b>190</b>	200	<b>210</b>	mV
$V_{ILED}$	Voltage at ILED Pin			500		mV
$V_{HR}$	Current Sink Headroom Voltage	Where $I_{LED} = 95\%$ of nominal, $R_{SET} = 20\Omega$		400		mV
$R_{DSON}$	NMOS Switch On Resistance	$I_{SW} = 100\text{mA}$		0.5		$\Omega$
	PMOS Switch On Resistance	$V_{OUT} = 10\text{V}, I_{SW} = 65\text{mA}$		2.2		
$I_{CL}$	NMOS Switch Current Limit		<b>370</b>	500	<b>620</b>	mA
$I_{LSW}$	SW Leakage Current	$V_{SW} = V_{IN} = 5.5\text{V}$ , OUT Floating, $V_{EN} = \text{PGND}$		0.01		$\mu\text{A}$
$I_{OUT\_SHUTDOWN}$	Output Pull-Down Resistance in Shutdown	$V_{EN} = 0\text{V}$		630		$\Omega$
$V_{OVP}$	Output Over-Voltage Protection	ON Threshold ( $V_{OUT}$ rising)	<b>17.5</b>	19.8	<b>21.8</b>	V
		OFF Threshold ( $V_{OUT}$ falling)		18.6		
$f_{SW}$	Switching Frequency	$3.0\text{V} < V_{IN} < 5.5\text{V}$	<b>715</b>	850	<b>1150</b>	kHz
$D_{MAX}$	Maximum Duty Cycle			91		%
$V_{SC}$	Output Voltage Threshold for Short Circuit Detection	$V_{OUT}$ Falling		$0.93 \times V_{IN}$		V
		$V_{OUT}$ Rising		$0.95 \times V_{IN}$		
$V_{EN\_TH}$	EN Threshold Voltage	On Threshold	<b>1.1</b>			V
		Off Threshold			<b>0.5</b>	
$V_{DIM\_TH}$	DIM Threshold Voltage	On Threshold	<b>1.1</b>			V
		Off Threshold			<b>0.5</b>	
$I_{DIM}$	DIM Bias Current (Note 8)	$V_{DIM} = 1.8\text{V}$		4.7		$\mu\text{A}$

Symbol	Parameter	Conditions	Min	Typ	Max	Units
$I_{EN}$	EN Bias Current (Note 8)	$V_{EN} = 1.8V$		4.7		$\mu A$
$I_{OUT}$	OUT Bias Current	$V_{OUT} = 16V$ , device not switching		420		$\mu A$
$R_{OUT\_SHUTDOWN}$	Output Pull-Down Resistance in Shutdown	$V_{EN} = 0V$ , $V_{OUT} < V_{IN}$		630		$\Omega$
$I_Q$	Quiescent Current Device Not Switching	$V_{ILED} > 0.5V$ , $3.0V < V_{IN} < 5.5V$ , SW Floating		0.18	<b>0.3</b>	mA
		$V_{EN} = 0V$ , $3.0V < V_{IN} < 5.5V$		0.01	<b>0.5</b>	
$I_{Q\_SW}$	Switching Supply Current			825		$\mu A$
$t_{START\_UP}$	From EN Low to High to Inductor Current Steady State	$V_{OUT} = 17V$ , $I_{LED} = 20mA$		470		$\mu s$

**Note 1:** Absolute maximum ratings are limits beyond which damage to the device may occur. Operating Ratings are conditions for which the device is intended to be functional, but device parameter specifications may not be guaranteed. For guaranteed specifications and test conditions, see the Electrical Characteristics.

**Note 2:** All voltages are with respect to PGND.

**Note 3:** Internal thermal shutdown circuitry protects the device from permanent damage. Thermal shutdown engages at  $T_J = +150^\circ C$  (typ.) and disengages at  $T_J = +140^\circ C$  (typ.).

**Note 4:** For more detailed soldering information and specifications, please refer to National Semiconductor Application Note 1112: Micro SMD Wafer Level Chip Scale Package (AN-1112), available at [www.national.com](http://www.national.com).

**Note 5:** In applications where high power dissipation and/or poor package thermal resistance is present, the maximum ambient temperature may have to be derated. Maximum ambient temperature ( $T_{A-MAX}$ ) is dependent on the maximum operating junction temperature ( $T_{J-MAX-OP} = +125^\circ C$ ), the maximum power dissipation of the device in the application ( $P_{D-MAX}$ ), and the junction-to ambient thermal resistance of the part/package in the application ( $\theta_{JA}$ ), as given by the following equation:  $T_{A-MAX} = T_{J-MAX-OP} - (\theta_{JA} \times P_{D-MAX})$ .

**Note 6:** Junction-to-ambient thermal resistance ( $\theta_{JA}$ ) is taken from thermal modeling performed under the conditions and guidelines set forth in the JEDEC standard JESD51-7. The test board is a 4-layer FR-4 board measuring (102mm x 76mm x 1.6mm) with a 2 x 1 array of thermal vias. The ground plane on the board is (50mm x 50mm). Thickness of copper layers are (36 $\mu m$ /18 $\mu m$ /18 $\mu m$ /36 $\mu m$ ) (1.5oz/1oz/1oz/1.5oz copper). Ambient temperature in simulation is +22 $^\circ C$ , still air. Power dissipation is 1W.

**Note 7:** Min and Max limits are guaranteed by design, test, or statistical analysis. Typical numbers are not guaranteed, but do represent the most likely norm. Unless otherwise specified, conditions for typical specifications are  $V_{IN} = 3.6V$ ,  $T_A = +25^\circ C$ .

**Note 8:** There is a typical 383k $\Omega$  pull-down on this pin.

**Note 9:** The human body model is a 100pF capacitor discharged through 1.5k $\Omega$  resistor into each pin. (MIL-STD-883 3015.7).

**Typical Performance Characteristics**  $V_{IN} = 3.6V$ ,  $R_{SET} = 10\Omega$ ,  $L = TDK VLF3012AT-220MR33$  (22 $\mu H$ ), LEDs are OSRAM (LW M67C),  $C_{OUT} = C_{IN} = 1\mu F$ ,  $T_A = +25^\circ C$ , unless otherwise noted.

**4 LED Efficiency vs  $I_{LED}$**   
( $L = TDK VLF3012AT-220MR33$ ,  $R_L = 0.66\Omega$ )

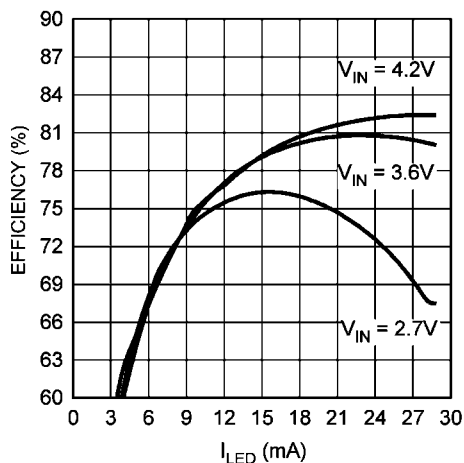

30004242

**3 LED Efficiency vs  $I_{LED}$**   
( $L = TDK VLF3012AT-220MR33$ ,  $R_L = 0.66\Omega$ )

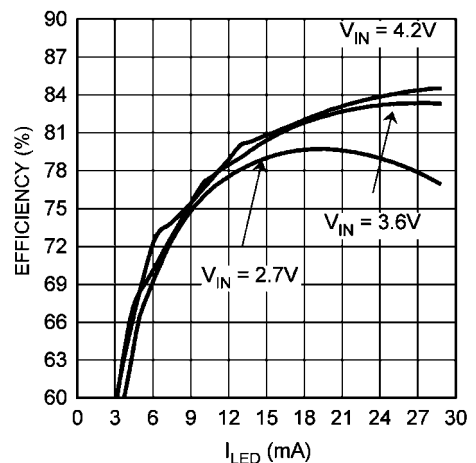

30004241

**2 LED Efficiency vs  $I_{LED}$**   
 (L = TDK VLF3012AT-220MR33,  $R_L = 0.66\Omega$ )

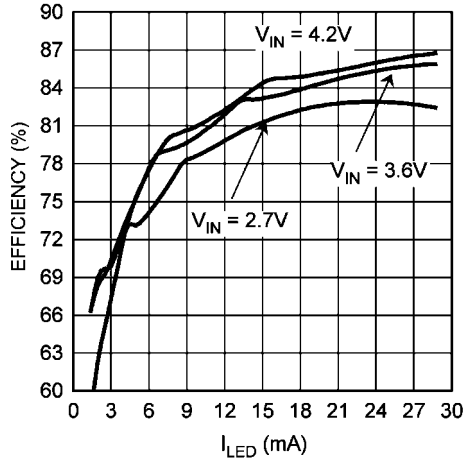

30004258

**Converter Output Voltage vs LED Current**

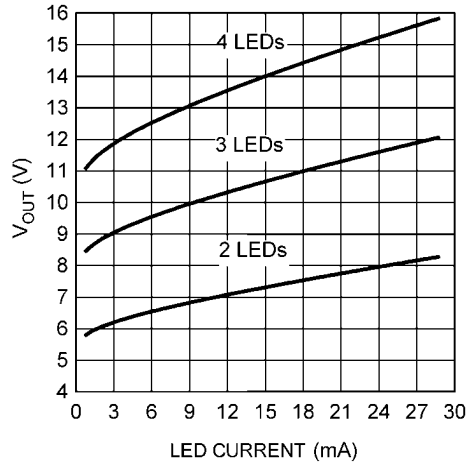

30004243

**Efficiency vs  $V_{IN}$  ( $I_{LED} = 20mA$ )**

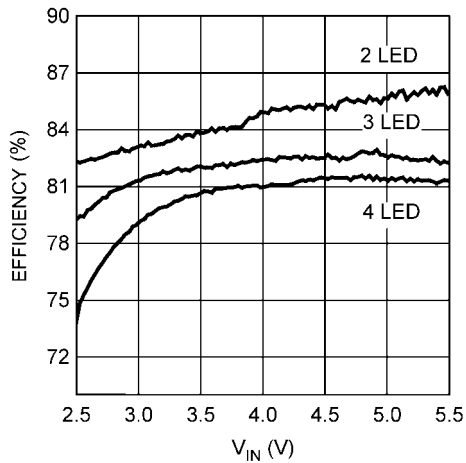

30004260

**Efficiency vs  $V_{IN}$  ( $I_{LED} = 30mA$ )**

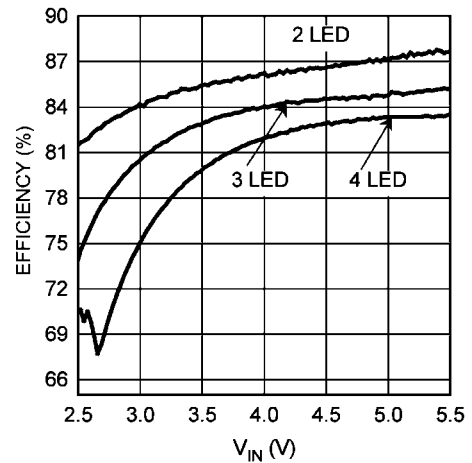

30004261

**Peak Current Limit vs  $V_{IN}$**

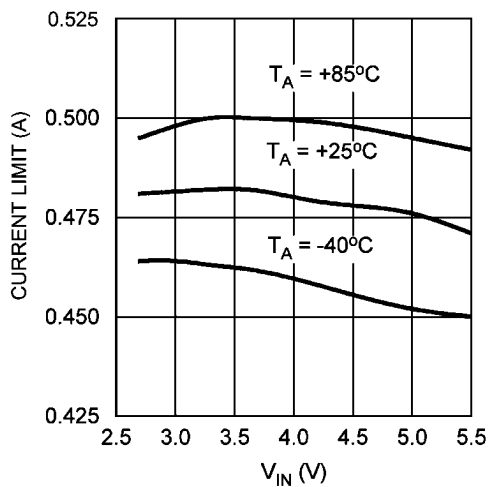

30004213

**Switching Frequency vs  $V_{IN}$**

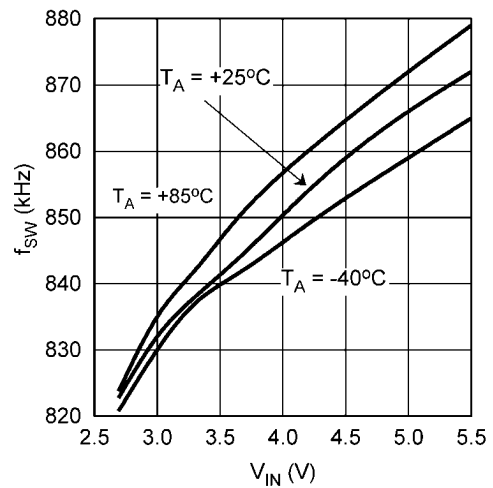

30004214

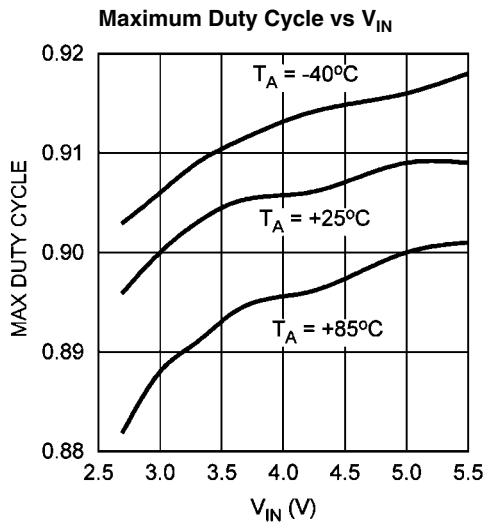

30004215

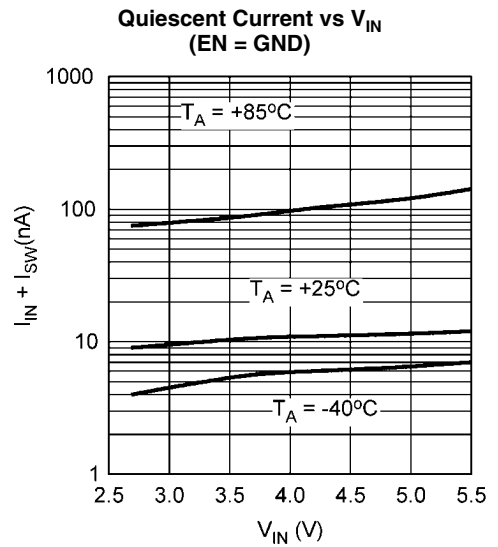

30004217

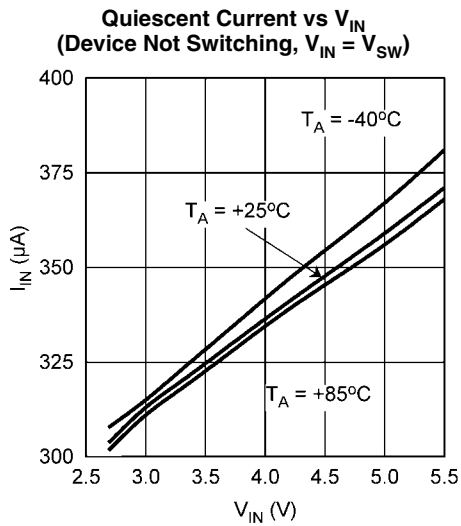

30004216

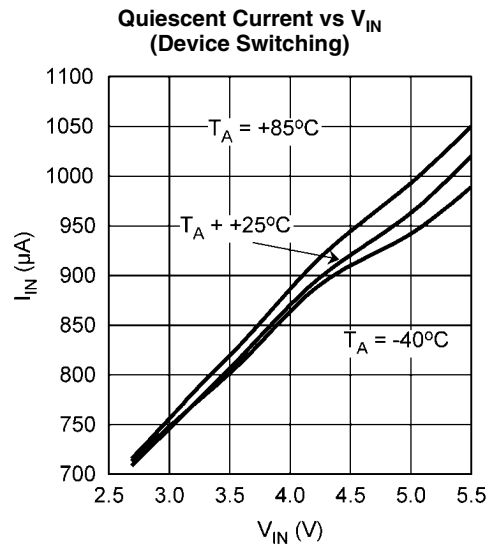

30004218

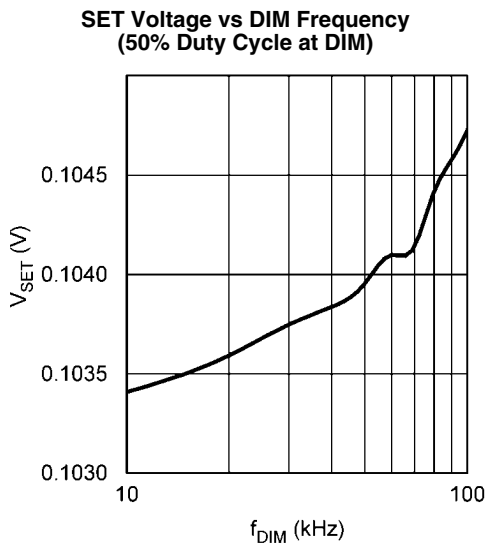

30004219

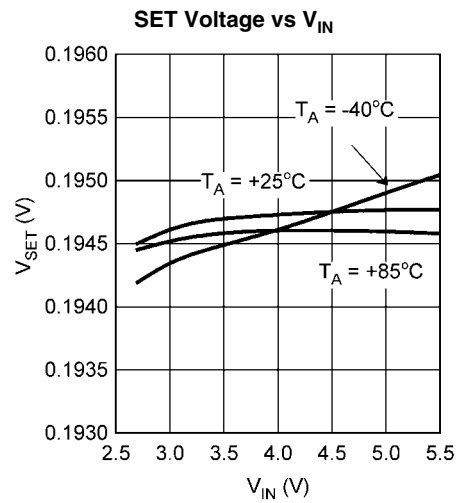

30004259

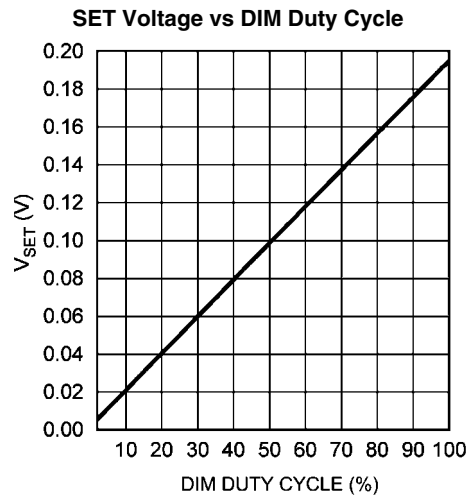

30004262

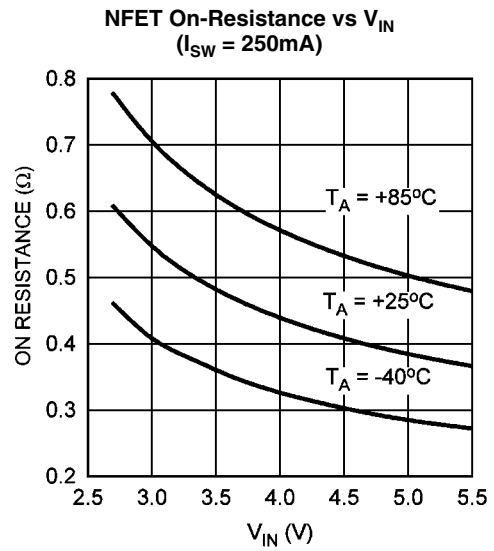

30004224

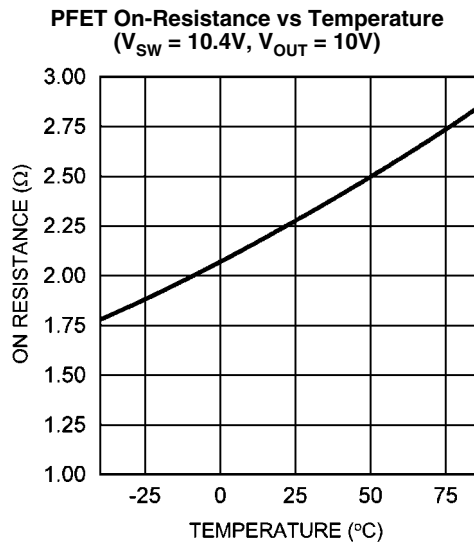

30004225

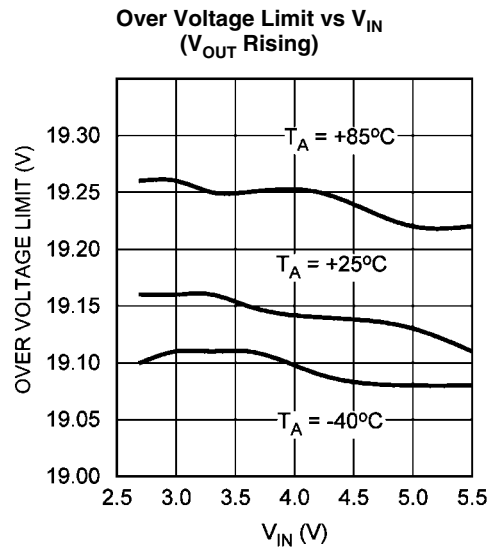

30004227

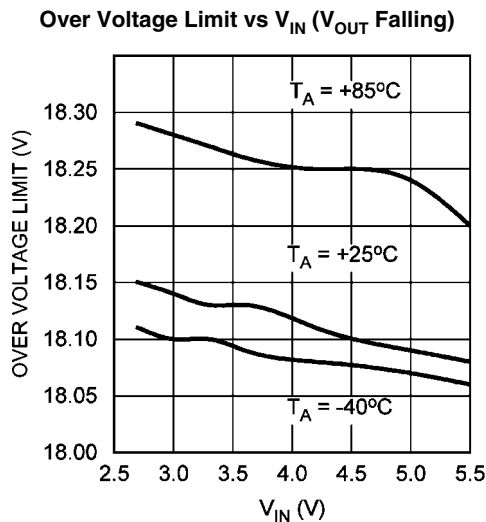

30004228

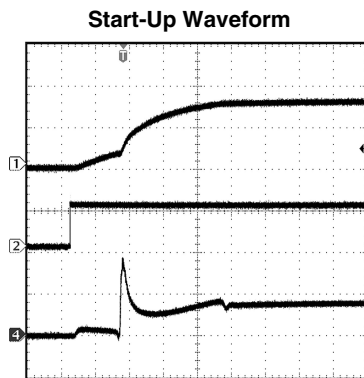

30004257

4 LEDs, I<sub>LED</sub> = 30mA, V<sub>IN</sub> = 3.6V  
 Channel 1: V<sub>OUT</sub> (10V/div)  
 Channel 2: EN (2V/div)  
 Channel 4: I<sub>IN</sub> (200mA/div)  
 Time Base: 100μs/div

**Over-Voltage Protection Function**

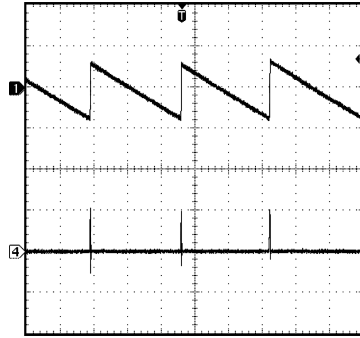

30004237

$V_{IN} = 3.6V$ ,  $V_{OUT} = 18.86V$   
 Channel 1:  $V_{OUT}$  (1V/div)  
 Channel 4:  $I_{IN}$  (500mA/div)  
 Time Base: 400 $\mu$ s/div

**Line-Step Response**

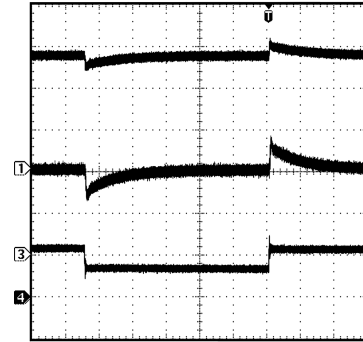

30004255

$V_{IN} = 3.6V$ , 4 LEDs  
 Channel 1:  $V_{OUT}$  (AC Copupled, 1V/div)  
 Channel 3:  $V_{IN}$  (AC Coupled, 500mV/div)  
 Channel 4:  $I_{LED}$  (DC Coupled, 5mA/div)  
 Time Base: 200 $\mu$ s/div

**Output Short-Circuit Response**

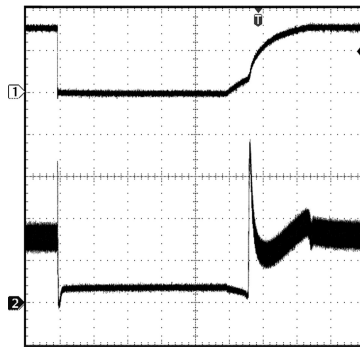

30004256

$V_{IN} = 3.6V$ ,  $I_{LED} = 30mA$   
 Channel 1:  $V_{OUT}$  (10V/div)  
 Channel 2:  $I_{IN}$  (100mA/div)  
 Time Base: 200 $\mu$ s/div

**Typical Operating Waveforms (DIM High)**

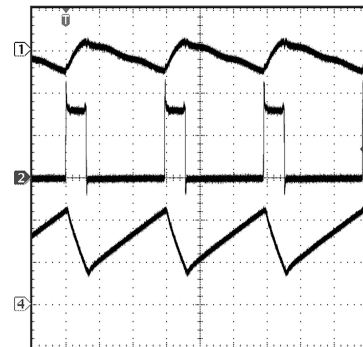

30004229

$V_{IN} = 3.6V$ , 4 LEDs,  $I_{LED} = 30mA$ ,  $V_{OUT} = 15.8V$   
 Channel 1:  $V_{OUT}$  (AC Coupled, 100mV/div)  
 Channel 2:  $V_{SW}$  (DC Coupled, 10V/div)  
 Channel 4:  $I_L$  (DC Coupled, 100mA/div)  
 Time Base: 400ns/div

**Typical Operating Waveforms (DIM With 20kHz Square Wave)**

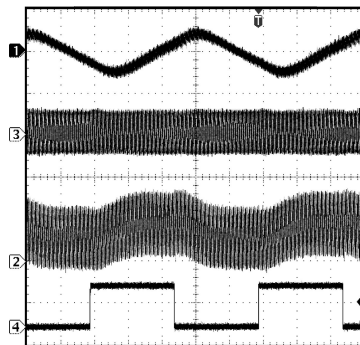

30004230

$V_{IN} = 3.6V$ , 4 LEDs,  $I_{LED} = 15mA$   
 Channel 1:  $V_{OUT}$  (AC Coupled, 200mV/div)  
 Channel 3:  $V_{IN}$  (AC Coupled, 100mV/div)  
 Channel 2:  $I_L$  (DC Coupled, 100mA/div)  
 Channel 4: DIM (DC Coupled, 2V/div)  
 Time Base: 10 $\mu$ s/div

**DIM Operation ( $I_{LED}$  changing from 30mA to 15mA)**

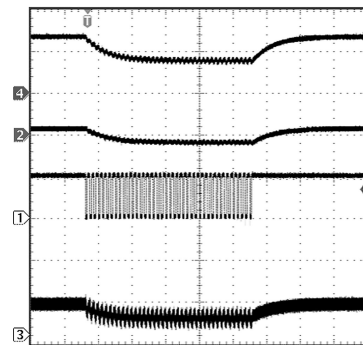

30004238

$V_{IN} = 3.6V$   
 Channel 4:  $I_{LED}$  (DC Coupled, 10mA/div)  
 Channel 2:  $V_{OUT}$  (AC Coupled, 2V/div)  
 Channel 1: DIM (DC Coupled, 2V/div, 20kHz, 50% duty cycle)  
 Channel 3:  $I_{IN}$  (DC Coupled, 200mA/div)  
 Time Base: 400 $\mu$ s/div



## Operation

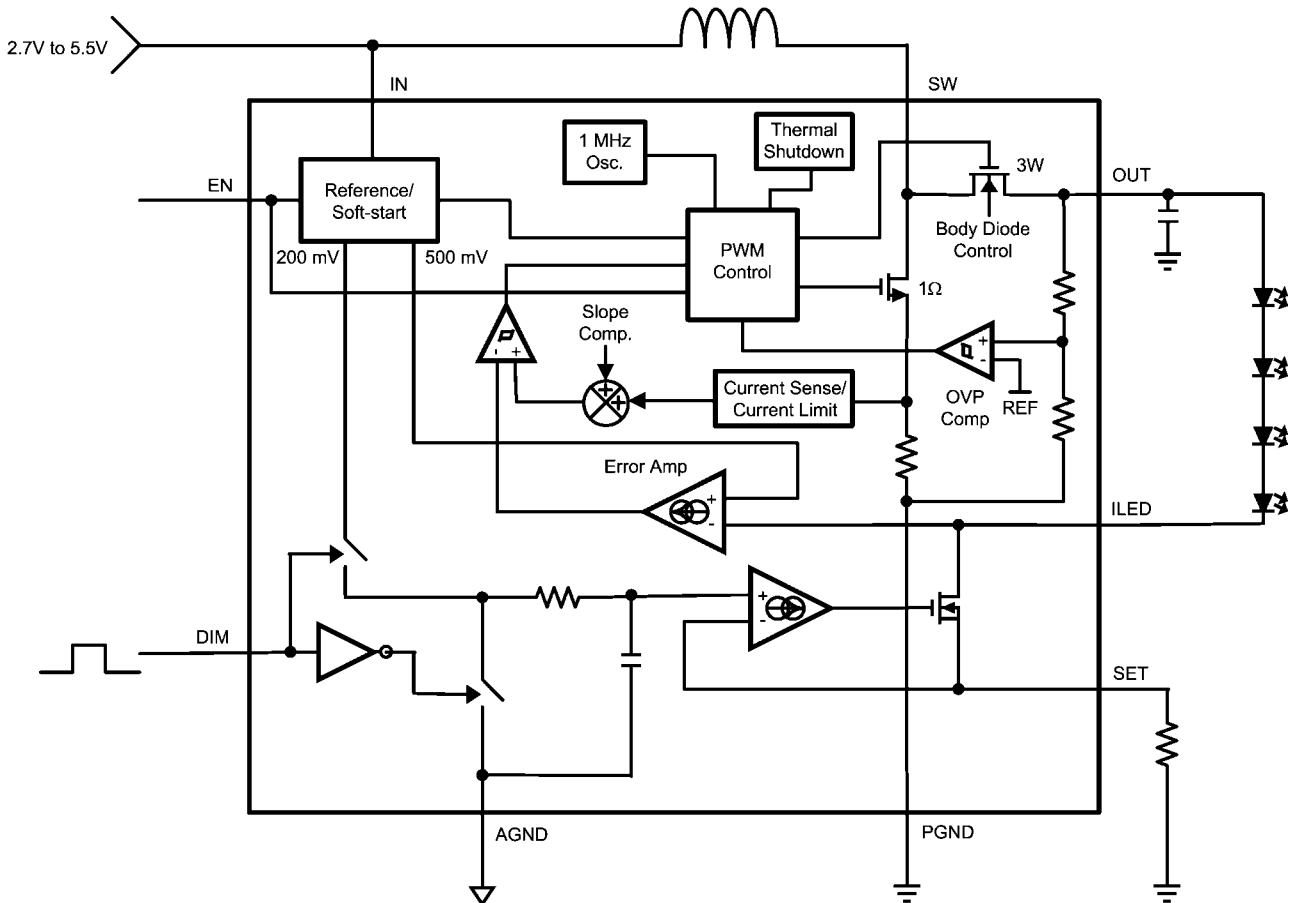

30004203

FIGURE 1. LM3508 Block Diagram

The LM3508 utilizes a synchronous step-up current mode PWM controller and a regulated current sink to provide a highly efficient and accurate LED current for white LED bias. The internal synchronous rectifier increases efficiency and eliminates the need for an external diode. Additionally, internal compensation eliminates the need for external compensation components resulting in a compact overall solution.

Figure 1 shows the detailed block diagram of the LM3508. The output of the boost converter (OUT) provides power to the series string of white LED's connected between OUT and ILED. The boost converter regulates the voltage at ILED to 500mV. This voltage is then used to power the internal current source whose output is at SET.

The first stage of the LM3508 consists of the synchronous boost converter. Operation is as follows: At the start of each switching cycle the oscillator sets the PWM controller. The controller turns the low side (NMOS) switch on and the synchronous rectifier (PMOS) switch off. During this time current ramps up in the inductor while the output capacitor supplies the current to the LED's. The error signal at the output of the error amplifier is compared against the sensed inductor current. When the sensed inductor current equals the error signal, or when the maximum duty cycle is reached, the NMOS switch turns off and the PMOS switch turns on. When the PMOS turns on, the inductor current ramps down, restoring energy to the output capacitor and supplying current to the

LED's. At the end of the clock period the PWM controller is again set and the process repeats itself. This action regulates ILED to 500mV.

The second stage of the LM3508 consists of an internal current source powered by the ILED voltage and providing a regulated current at SET. The regulated LED current is set by connecting an external resistor from SET to PGND.  $V_{SET}$  is adjusted from 0 to 200mV by applying a PWM signal of up to typically 100kHz at DIM (see Typical Performance Characteristic of SET voltage vs DIM frequency). The PWM signal at DIM modulates the internal 200mV reference and applies it to an internal RC filter resulting in an adjustable SET voltage and thus an adjustable LED current.

## Start-Up

The LM3508 features a soft-start to prevent large inrush currents during start-up that can cause excessive voltage ripple on VIN. During start-up the average input current is ramped up at a controlled rate. For the typical application circuit, driving 4LED's from a 3.6V lithium battery at 30mA, when EN is driven high the average input current ramps from zero to 160mA in 470 $\mu$ s. See plot of Soft Start functionality in the Typical Performance Characteristics.

## DIM Operation

DIM is the input to the gate of an internal switch that accepts a logic level PWM waveform and modulates the internal 200mV reference through an internal RC filter. This forces the current source regulation point ( $V_{SET}$ ) to vary by the duty cycle (D) of the DIM waveform making  $I_{LED} = D \times 200\text{mV} / R_{SET}$ . The cutoff frequency for the filter is approximately 500Hz. DIM frequencies higher than 100kHz cause the LED current to drastically deviate from their nominal set points. The graphs of SET voltage vs DIM frequency, SET voltage vs  $V_{IN}$  and SET voltage vs DIM duty cycle (see Typical Performance Characteristics) show the typical variation of the current source set point voltage.

## Enable Input and Output Isolation

Driving EN high turns the device on while driving EN low places the LM3508 in shutdown. In shutdown the supply current reduces to less than 1 $\mu$ A, the internal synchronous PFET turns off as well as the current source (N2 in figure 1). This completely isolates the output from the input and prevents leakage current from flowing through the LED's. In shutdown the leakage current into SW and IN is typically 400nA. EN has an internal 383k $\Omega$  pull-down to PGND.

## Peak Current Limit/Maximum Output Current

The LM3508 boost converter provides a peak current limit. When the peak inductor current reaches the peak current limit the duty cycle is terminated. This results in a limit on the maximum output power and thus the maximum output current the LM3508 can deliver. Calculate the maximum LED current as a function of  $V_{IN}$ ,  $V_{OUT}$ , L and  $I_{PEAK}$  as:

$$I_{LED\_MAX} = \frac{(I_{PEAK} - \Delta I_L) \times \eta \times V_{IN}}{V_{OUT}}$$

$$\text{where } \Delta I_L = \frac{V_{IN} \times (V_{OUT} - V_{IN})}{2 \times f_{SW} \times L \times V_{OUT}}$$

and  $f_{SW} = 850\text{kHz}$ . Efficiency and  $I_{PEAK}$  can be found in the efficiency and  $I_{PEAK}$  curves in the Typical Performance Characteristics.

## Output Current Accuracy

The LM3508 provides highly accurate output current regulation of  $\pm 5\%$  over the 3V to 5.5V input voltage range. Accuracy depends on various key factors. Among these are; the tolerance of  $R_{SET}$ , the frequency at DIM ( $f_{DIM}$ ), and the errors internal to the LM3508 controller and current sink. For best accuracy, use a 1% resistor for  $R_{SET}$  and keep  $f_{DIM}$  between 1kHz and 100kHz. Refer to the Typical Performance Characteristics for  $V_{SET}$  vs  $V_{IN}$ ,  $V_{SET}$  vs  $f_{DIM}$ , and  $V_{SET}$  vs DIM duty cycle.

## Voltage Head Room at ILED

If the LED current is increased to a point where the peak inductor current is reached, the boost converter's on-time is terminated until the next switching cycle. If the LED current is further increased the 500mV regulated voltage at ILED begins to drop. When  $V_{ILED}$  drops below the current sink headroom voltage ( $V_{HR} = 400\text{mV}$  typ.) the current sink FET (see N2 in

figure 1) will be fully on, appearing as a 5 $\Omega$  resistor between ILED and SET.

## Output Short Circuit Protection

The LM3508 provides a short circuit protection that limits the output current if OUT is shorted to PGND. During a short at OUT when  $V_{OUT}$  falls to below  $V_{IN} \times 0.93$ , switching will stop. The PMOS will turn into a current source and limit the output current to 35mA. The LM3508 can survive with a continuous short at the output. The threshold for OUT recovering from a short circuit condition is typically  $V_{IN} \times 0.95$ .

## Output Over-Voltage Protection

When the load at the output of the LM3508 goes high impedance the boost converter will raise  $V_{OUT}$  to try and maintain the programmed LED current. To prevent over-voltage conditions that can damage output capacitors and/or the device, the LM3508 will clamp the output at a maximum of 21.8V. This allows for the use of 25V output capacitors available in a tiny 1.6mm  $\times$  0.8mm case size.

During output open circuit conditions when the output voltage rises to the over voltage protection threshold ( $V_{OVP} = 19.8\text{V}$  typical) the OVP circuitry will shut off both the NMOS and PMOS switches. When the output voltage drops below 18.6V (typically) the converter will begin switching again. If the device remains in an over voltage condition the cycle will be repeated resulting in a pulsed condition at the output. See waveform for OVP condition in the Typical Performance Characteristics.

## Light Load Operation

During light load conditions when the inductor current reaches zero before the end of the switching period, the PFET will turn off, disconnecting OUT from SW and forcing the converter into discontinuous conduction. At the beginning of the next switching cycle, switching will resume. (see plot of discontinuous conduction mode in the Typical Performance Characteristics graphs).

Boost converters that operate in the discontinuous conduction mode with fixed input to output conversion ratios ( $V_{OUT}/V_{IN}$ ) have load dependent duty cycles, resulting in shorter switch on-times as the load decreases. As the load is decreased the duty cycle will fall until the converter hits its minimum duty cycle (typically 15%). To prevent further decreases in the load current altering the  $V_{OUT}/V_{IN}$  ratio, the LM3508 will enter a pulsed skip mode. In pulse skip mode the device will only switch as necessary to keep the LED current in regulation.

## Thermal Shutdown

The LM3508 provides a thermal shutdown feature. When the die temperature exceeds +150 $^{\circ}\text{C}$  the part will shutdown, turning off both the NMOS and PMOS FET's. The part will start-up again with a soft-start sequence when the die temperature falls below +115 $^{\circ}\text{C}$ .

## Applications Information

### Brightness Adjustment

A logic high at DIM forces SET to regulate to 200mV. Adjust the maximum LED current by picking  $R_{SET}$  (the resistor from SET to GND) such that:

$$I_{LED\_MAX} = \frac{200 \text{ mV}}{R_{SET}}$$

Once  $I_{LED\_MAX}$  is set, the LED current can be adjusted from  $I_{LED\_MAX}$  down to  $I_{LED\_MIN}$  by applying a logic level PWM signal to DIM. This results in:

$$I_{LED} = \frac{D \times 200 \text{ mV}}{R_{SET}}$$

where D is the duty cycle of the PWM pulse applied to DIM. The LM3508 can be brought out of shutdown while a signal is applied to DIM, allowing the device to turn on into a low LED current mode. A logic low at DIM will shut off the current source making  $I_{LED}$  high impedance however, the boost converter continues to operate. Due to an offset voltage at SET (approximately +/-2mV) the LED's can faintly illuminate even with DIM pulled to GND. If zero LED current is required then pulling EN low will shutdown the current source causing the LED current to drop to zero. DIM has an internal 383kΩ pull down to PGND.

### Input Capacitor Selection

Choosing the correct size and type of input capacitor helps minimize the input voltage ripple caused by the switching action of the LM3508's boost converter. For continuous inductor current operation the input voltage ripple is composed of 2 primary components, the capacitor discharge (delta  $V_Q$ ) and the capacitor's equivalent series resistance (delta  $V_{ESR}$ ). The ripple due to strictly to the capacitor discharge is:

$$\Delta V_Q = \frac{\Delta I_L \times D}{2 \times f_{SW} \times C_{IN}}$$

The ripple due to strictly to the capacitors ESR is:

$$\Delta V_{ESR} = 2 \times I_L \times R_{ESR}$$

$$\text{where } \Delta I_L = \frac{V_{IN} \times (V_{OUT} - V_{IN})}{2 \times f_{SW} \times L \times V_{OUT}}$$

In the typical application circuit, a 1μF ceramic input capacitor works well. Since the ESR in ceramic capacitors is typically less than 5mΩ and the capacitance value is usually small, the input voltage ripple is primarily due to the capacitive discharge. With larger value capacitors such as tantalum or aluminum electrolytic the ESR can be greater than 0.5Ω. In this case the input ripple will primarily be due to the ESR.

### Output Capacitor Selection

In a boost converter such as the LM3508, during the on time, the inductor is disconnected from OUT forcing the output capacitor to supply the LED current. When the PMOS switch (synchronous rectifier) turns on the inductor energy supplies the LED current and restores charge to the output capacitor. This action causes a sag in the output voltage during the on time and a rise in the output voltage during the off time.

The LM3508's output capacitor is chosen to limit the output ripple to an acceptable level and to ensure the boost converter is stable. For proper operation use a 1μF ceramic output capacitor. Values of 2.2μF or 4.7μF can be used although start-up current and start-up time will be increased. As with the

input capacitor, the output voltage ripple is composed of two parts, the ripple due to capacitor discharge (delta  $V_Q$ ) and the ripple due to the capacitors ESR (delta  $V_{ESR}$ ). Most of the time the LM3508 will operate in continuous conduction mode. In this mode the ripple due to capacitor discharge is given by:

$$\Delta V_Q = \frac{I_{LED} \times (V_{OUT} - V_{IN})}{f_{SW} \times V_{OUT} \times C_{OUT}}$$

The output voltage ripple component due to the output capacitors ESR is found by:

$$\Delta V_{ESR} = R_{ESR} \times \left( \frac{I_{LED} \times V_{IN}}{V_{IN}} + \Delta I_L \right)$$

$$\text{where } \Delta I_L = \frac{V_{IN} \times (V_{OUT} - V_{IN})}{2 \times f_{SW} \times L \times V_{OUT}}$$

**Table 1. Recommended Output Capacitor Manufacturers**

Manufacturer	Part Number	Value	Case Size	Voltage Rating
Murata	GRM39X5	1μF	0603	25V
	R105K25 D539			
TDK	C1608X5 R1E105M	1μF	0603	25V

### Inductor Selection

The LM3508 is designed to operate with 10μH to 22μH inductor's. When choosing the inductor ensure that the inductor's saturation current rating is greater than

$$\frac{I_{LED}}{\eta} \times \frac{V_{OUT}}{V_{IN}} + \Delta I_L$$

$$\text{where } \Delta I_L = \frac{V_{IN} \times (V_{OUT} - V_{IN})}{2 \times f_{SW} \times L \times V_{OUT}}$$

Additionally, the inductor's value should be large enough such that at the maximum LED current, the peak inductor current is less than the LM3508's peak switch current limit. This is done by choosing L such that

$$L > \frac{V_{IN} \times (V_{OUT} - V_{IN})}{2 \times f_{SW} \times L \times V_{OUT} \times \left( I_{PEAK} - \frac{I_{LED\_MAX} \times V_{OUT}}{\eta \times V_{IN}} \right)}$$

Values for  $I_{PEAK}$  and efficiency can be found in the plot of peak current limit vs.  $V_{IN}$  in the Typical Performance Characteristics graphs.

**Table 2. Recommended Inductor Manufacturers**

Manufacturer	L	Part Number	Size	Saturation Current
TDK	22 $\mu$ H	VLF3010 AT-220M R33	2.6mm $\times$ 2.8mm $\times$ 1mm	330mA
TDK	22 $\mu$ H	VLF3012 AT-220M R33	2.6mm $\times$ 2.8mm $\times$ 1.2mm	330mA
Toko	22 $\mu$ H	D3313FB (1036FB-220M)	3.3mm $\times$ 3.3mm $\times$ 1.3mm	350mA

**Layout Considerations**

Proper layout is essential for stable, jitter free operation, and good efficiency. Follow these steps to ensure a good layout.

1, Use a separate ground plane for power ground (PGND) and analog ground (AGND).

2, Keep high current paths such as SW and PGND connections short.

3, Connect the return terminals for the input capacitor and the output capacitor together at a single point as close as possible to PGND.

4, Connect PGND and AGND together as close as possible to the IC. Do not connect them together anywhere else.

5, Connect the input capacitor ( $C_{IN}$ ) as close as possible to IN.

6, Connect the output capacitor ( $C_{OUT}$ ) as close as possible to OUT.

7, Connect the positive terminal of  $R_{SET}$  as close as possible to ILED and the negative terminal as close as possible to PGND. This ensures accurate current programming.

**Physical Dimensions** inches (millimeters) unless otherwise noted

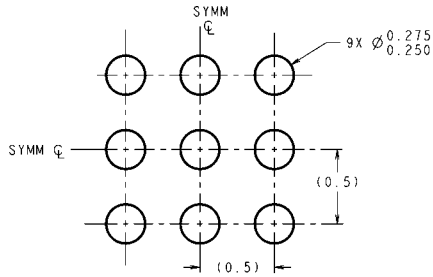

DIMENSIONS ARE IN MILLIMETERS  
DIMENSIONS IN ( ) FOR REFERENCE ONLY

**LAND PATTERN RECOMMENDATION**

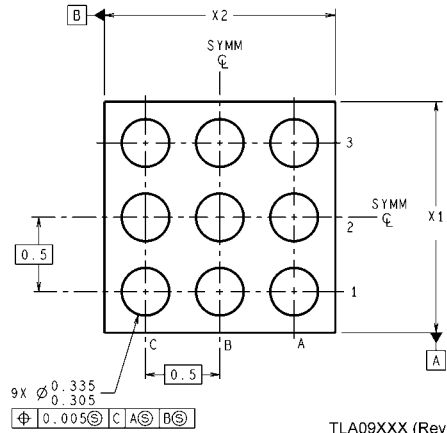
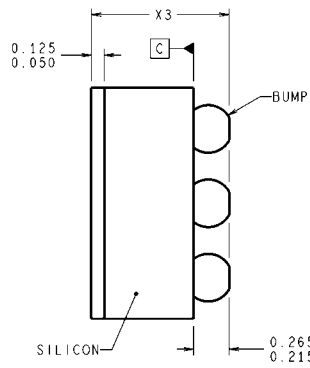
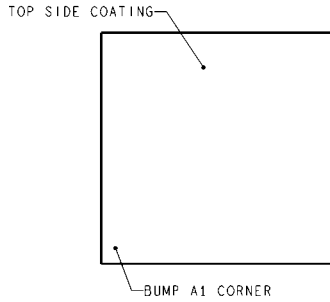

TLA09XXX (Rev C)

**9-Bump Micro SMD Package (TL09AAA)**  
**For Ordering, Refer to Ordering Information Table**  
**NS Package Number TLA09AAA**  
**X1 = 1.514mm ( $\pm$ 0.03mm), X2 = 1.514mm ( $\pm$ 0.03mm), X3 = 0.6mm ( $\pm$ 0.075mm)**

## Notes

For more National Semiconductor product information and proven design tools, visit the following Web sites at:

Products		Design Support	
Amplifiers	<a href="http://www.national.com/amplifiers">www.national.com/amplifiers</a>	WEBENCH	<a href="http://www.national.com/webench">www.national.com/webench</a>
Audio	<a href="http://www.national.com/audio">www.national.com/audio</a>	Analog University	<a href="http://www.national.com/AU">www.national.com/AU</a>
Clock Conditioners	<a href="http://www.national.com/timing">www.national.com/timing</a>	App Notes	<a href="http://www.national.com/appnotes">www.national.com/appnotes</a>
Data Converters	<a href="http://www.national.com/adc">www.national.com/adc</a>	Distributors	<a href="http://www.national.com/contacts">www.national.com/contacts</a>
Displays	<a href="http://www.national.com/displays">www.national.com/displays</a>	Green Compliance	<a href="http://www.national.com/quality/green">www.national.com/quality/green</a>
Ethernet	<a href="http://www.national.com/ethernet">www.national.com/ethernet</a>	Packaging	<a href="http://www.national.com/packaging">www.national.com/packaging</a>
Interface	<a href="http://www.national.com/interface">www.national.com/interface</a>	Quality and Reliability	<a href="http://www.national.com/quality">www.national.com/quality</a>
LVDS	<a href="http://www.national.com/lvds">www.national.com/lvds</a>	Reference Designs	<a href="http://www.national.com/refdesigns">www.national.com/refdesigns</a>
Power Management	<a href="http://www.national.com/power">www.national.com/power</a>	Feedback	<a href="http://www.national.com/feedback">www.national.com/feedback</a>
Switching Regulators	<a href="http://www.national.com/switchers">www.national.com/switchers</a>		
LDOs	<a href="http://www.national.com/ldo">www.national.com/ldo</a>		
LED Lighting	<a href="http://www.national.com/led">www.national.com/led</a>		
PowerWise	<a href="http://www.national.com/powerwise">www.national.com/powerwise</a>		
Serial Digital Interface (SDI)	<a href="http://www.national.com/sdi">www.national.com/sdi</a>		
Temperature Sensors	<a href="http://www.national.com/tempsensors">www.national.com/tempsensors</a>		
Wireless (PLL/VCO)	<a href="http://www.national.com/wireless">www.national.com/wireless</a>		

THE CONTENTS OF THIS DOCUMENT ARE PROVIDED IN CONNECTION WITH NATIONAL SEMICONDUCTOR CORPORATION ("NATIONAL") PRODUCTS. NATIONAL MAKES NO REPRESENTATIONS OR WARRANTIES WITH RESPECT TO THE ACCURACY OR COMPLETENESS OF THE CONTENTS OF THIS PUBLICATION AND RESERVES THE RIGHT TO MAKE CHANGES TO SPECIFICATIONS AND PRODUCT DESCRIPTIONS AT ANY TIME WITHOUT NOTICE. NO LICENSE, WHETHER EXPRESS, IMPLIED, ARISING BY ESTOPPEL OR OTHERWISE, TO ANY INTELLECTUAL PROPERTY RIGHTS IS GRANTED BY THIS DOCUMENT.

TESTING AND OTHER QUALITY CONTROLS ARE USED TO THE EXTENT NATIONAL DEEMS NECESSARY TO SUPPORT NATIONAL'S PRODUCT WARRANTY. EXCEPT WHERE MANDATED BY GOVERNMENT REQUIREMENTS, TESTING OF ALL PARAMETERS OF EACH PRODUCT IS NOT NECESSARILY PERFORMED. NATIONAL ASSUMES NO LIABILITY FOR APPLICATIONS ASSISTANCE OR BUYER PRODUCT DESIGN. BUYERS ARE RESPONSIBLE FOR THEIR PRODUCTS AND APPLICATIONS USING NATIONAL COMPONENTS. PRIOR TO USING OR DISTRIBUTING ANY PRODUCTS THAT INCLUDE NATIONAL COMPONENTS, BUYERS SHOULD PROVIDE ADEQUATE DESIGN, TESTING AND OPERATING SAFEGUARDS.

EXCEPT AS PROVIDED IN NATIONAL'S TERMS AND CONDITIONS OF SALE FOR SUCH PRODUCTS, NATIONAL ASSUMES NO LIABILITY WHATSOEVER, AND NATIONAL DISCLAIMS ANY EXPRESS OR IMPLIED WARRANTY RELATING TO THE SALE AND/OR USE OF NATIONAL PRODUCTS INCLUDING LIABILITY OR WARRANTIES RELATING TO FITNESS FOR A PARTICULAR PURPOSE, MERCHANTABILITY, OR INFRINGEMENT OF ANY PATENT, COPYRIGHT OR OTHER INTELLECTUAL PROPERTY RIGHT.

### LIFE SUPPORT POLICY

**NATIONAL'S PRODUCTS ARE NOT AUTHORIZED FOR USE AS CRITICAL COMPONENTS IN LIFE SUPPORT DEVICES OR SYSTEMS WITHOUT THE EXPRESS PRIOR WRITTEN APPROVAL OF THE CHIEF EXECUTIVE OFFICER AND GENERAL COUNSEL OF NATIONAL SEMICONDUCTOR CORPORATION.** As used herein:

Life support devices or systems are devices which (a) are intended for surgical implant into the body, or (b) support or sustain life and whose failure to perform when properly used in accordance with instructions for use provided in the labeling can be reasonably expected to result in a significant injury to the user. A critical component is any component in a life support device or system whose failure to perform can be reasonably expected to cause the failure of the life support device or system or to affect its safety or effectiveness.

National Semiconductor and the National Semiconductor logo are registered trademarks of National Semiconductor Corporation. All other brand or product names may be trademarks or registered trademarks of their respective holders.

Copyright© 2008 National Semiconductor Corporation

For the most current product information visit us at [www.national.com](http://www.national.com)



**National Semiconductor  
Americas Technical  
Support Center**  
Email:  
[new.feedback@nsc.com](mailto:new.feedback@nsc.com)  
Tel: 1-800-272-9959

**National Semiconductor Europe  
Technical Support Center**  
Email: [europe.support@nsc.com](mailto:europe.support@nsc.com)  
German Tel: +49 (0) 180 5010 771  
English Tel: +44 (0) 870 850 4288

**National Semiconductor Asia  
Pacific Technical Support Center**  
Email: [ap.support@nsc.com](mailto:ap.support@nsc.com)

**National Semiconductor Japan  
Technical Support Center**  
Email: [jpn.feedback@nsc.com](mailto:jpn.feedback@nsc.com)